



TRAC 12

Project: _____

Fixture Type: _____

Location: _____

Contact/Phone: _____

Miniature Low Voltage Trac System

LINEAR LAMPHOLDERS & BI-PIN FLOOD

TL201, TL202, TL211, TL212 and TL103

PRODUCT DESCRIPTION

A miniature low voltage linear lighting system for undercabinet and cove applications.

Transformer Refer to specification sheets [D3.1.2](#) and [D3.1.3](#).

Trac Refer to specification sheet [D3.1.0](#).

Labels UL listed, CSA certified.

Specifications subject to change without notice.

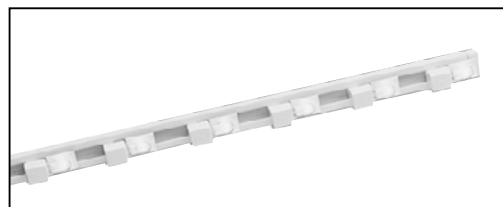

Low Voltage T3-1/4 Single Lampholder

Wedge base lampholders are an economical choice for linear lighting applications. They have a minimal profile and produce bright, uniform illumination. They have stationary aluminum reflectors to forward project more of the 360° light from the lamp. They are compatible with wedge base lamps that are 10W or less and T3-1/4 size or smaller including xenon, LED, etc. Xenon lamps emit a white light that approximates the color of halogen, but have up to a 20,000-hour lamp life and do not require fixture lenses or special handling.

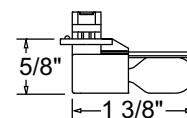

Catalog Number	Finish	Lamp
TL201 WH	White	One T3 1/4, 10W max. wedge base lamp, 12V or 24V
TL201 BL	Black	One T3 1/4, 10W max. wedge base lamp, 12V or 24V

Low Voltage T3-1/4 Single Lampholder

Similar to the TL201 above, but with two lamp sockets for dual lamp compatibility.

Catalog Number	Finish	Lamp
TL202 WH	White	Two T3 1/4, 10W max. wedge base lamps, 12V or 24V
TL202 BL	Black	Two T3 1/4, 10W max. wedge base lamps, 12V or 24V

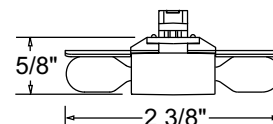

XENON T3 1/4 WEDGE BASE LAMPS

Catalog Number	Finish	Watt/Volts	Initial Lumens	Life (Hours)
TL900 CLR	Clear	3W/12V	15	20,000
TL901 CLR	Clear	5W/12V	30	15,000
TL903 CLR	Clear	10W/12V	71	20,000
TL905 FRST 24	Frosted	5W/24V	27	10,000
TL910 FRST 24	Frosted	10W/24V	85	10,000

TRAC 12

Miniature Low Voltage Trac System

LINEAR LAMPHOLDERS & BI-PIN FLOOD**TL201, TL202, TL211, TL212 and TL103****Low Voltage T3-1/4 Rigid Loop Lampholder**

Rigid loop lampholders are ideally suited for linear lighting applications. They have a low profile and produce bright, uniform illumination. The rigid loop lampholder includes a stationary reflector to forward project more of the 360° light from the lamp. They are compatible with rigid loop style lamps that are 10W or less and T3-1/4 size or smaller including xenon, LED, etc. Rigid loop lamps possess all of the advantages of the wedge base lamps, but offer a more symmetrical light distribution and slightly higher output that is optimal for cove lighting applications. Xenon lamps emit a white light that approximates the color of halogen, but have up to a 20,000-hour lamp life and do not require fixture lenses or special handling.

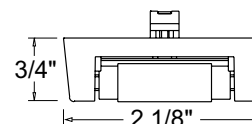

Catalog Number	Finish	Lamp
TL211 WH	White	One T3 1/4, 10W max. rigid base lamp, 12V or 24V
TL211 BL	Black	One T3 1/4, 10W max. rigid base lamp, 12V or 24V

XENON T3¹/₄ RIGID LOOP LAMPS

Catalog Number	Finish	Watt/Volts	Initial Lumens	Life (Hours)
TL950 CLR	Clear	12V-5W Rigid Loop Lamp	45	20,000
TL950 FRST	Frost	12V-5W Rigid Loop Lamp	45	20,000
TL951 CLR	Clear	12V-10W Rigid Loop Lamp	100	20,000
TL951 FRST	Frost	12V-10W Rigid Loop Lamp	100	20,000
TL952 CLR 24	Clear	24V-5W Rigid Loop Lamp	40	20,000
TL952 FRST 24	Frost	24V-5W Rigid Loop Lamp	40	20,000
TL953 CLR 24	Clear	24V-10W Rigid Loop Lamp	90	20,000
TL953 FRST 24	Frost	24V-10W Rigid Loop Lamp	90	20,000

TRAC 12

Miniature Low Voltage Trac System

LINEAR LAMPHOLDERS & BI-PIN FLOOD

TL201, TL202, TL211, TL212 and TL103

Low Voltage T3-1/4 Festoon Lampholder

Festoon lampholders are ideally suited for linear lighting applications. They have a low profile and produce bright, uniform illumination. The festoon lampholder includes an articulating reflector, enabling more precise aiming of the light. They are compatible with festoon type lamps that are 10W or less and T3-1/4 size or smaller including xenon, LED, etc. The festoon lamp is similar to the rigid loop lamp, though more widely available and offering slightly greater light output. Xenon lamps emit a white light that approximates the color of halogen, but have up to a 20,000-hour lamp life and do not require fixture lenses or special handling.

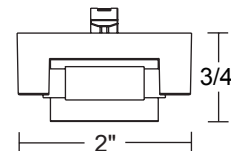

Catalog Number	Finish	Lamp
TL212 WH	White	One T3 1/4, 10W max. festoon lamp, 12V or 24V

XENON T3 1/4 FESTOON LAMPS

Catalog Number	Finish	Wattage/Volts	Initial Lumens	Life (Hours)
TL960 CLR	Clear	12V-5W Rigid Loop Lamp	50	20,000
TL960 FRST	Frost	12V-5W Rigid Loop Lamp	50	20,000
TL961 CLR	Clear	12V-10W Rigid Loop Lamp	120	20,000
TL961 FRST	Frost	12V-10W Rigid Loop Lamp	120	20,000
TL964 CLR 24	Clear	24V-5W Rigid Loop Lamp	50	20,000
TL964 FRST 24	Frost	24V-5W Rigid Loop Lamp	50	20,000
TL965 CLR 24	Clear	24V-10W Rigid Loop Lamp	120	20,000
TL965 FRST 24	Frost	24V-10W Rigid Loop Lamp	120	20,000

Low Voltage T3 Bi-Pin Flood

Lens Slide-on frosted lens enables lamp replacement without tools.

Catalog Number	Finish	Lamp
TL103 WH	White	One T3, 20W max. bi-pin lamp, 12V or 24V
TL103 BL	Black	One T3, 20W max. bi-pin lamp, 12V or 24V

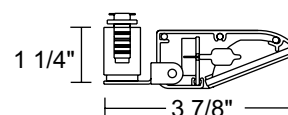

XENON T3 BI-PIN LAMPS

Description Clear 12 volt or 24 volt T3 bi-pin halogen lamps.

Catalog Number	Wattage/Volts	Initial Lumens	Life (Hours)
TL923	20W/12V	350	2,000
TL924	20W/24V	288	2,000

TRAC 12

Miniature Low Voltage Trac System

LINEAR LAMPHOLDERS & BI-PIN FLOOD

TL201, TL202, TL211, TL212 and TL103

Cabinetry Lighting Guidelines

Over Cabinets The Trac 12® system, using 10-watt lamps spaced 6" on center, generally provides excellent indirect lighting. For lower-level mood lighting, use 3-watt or 5-watt lamps with slightly closer spacing. Placing the fixture at the front edge of the cabinet top will project light into the space and illuminate any displayed objects. Locate top of lamp even with top edge of cove molding to prevent a harsh shadow line.

Inside Cabinets Running the Trac 12 system vertical on the front inside of cabinets avoids the need to put trac on each shelf. 3-watt Xenon lamps 3" on center will generally provide adequate lighting inside a cabinet.

Under Cabinets Placing the Juno Trac 12 system at the front lip of the cabinet conceals the fixture from view, minimizes veiling reflections, and provides maximum light on the working area of the countertop.

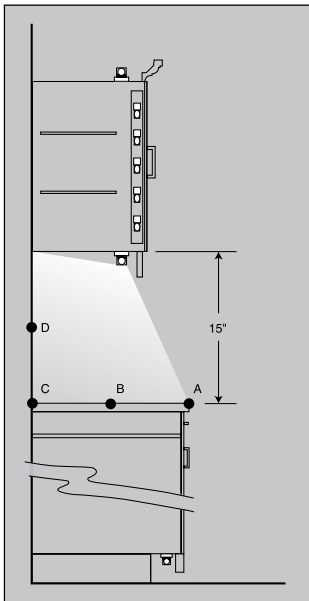

Footcandles on Horizontal Work Surface

Lamp Type	Catalog Number	Number of Lamps	Volts/Watts	On-Center Spacing	Footcandles			
					A	B	C	D
Xenon Wedge Base	TL201	1	12V/5W	3"	10	31	20	22
		1	12V/10W	6"	12	36	23	25
	TL202	2	12V/5W	6"	10	29	18	20
		2	12V/10W	12"	12	36	23	25
Xenon Rigid Loop	TL211	1	12V/5W	3"	14	42	27	30
		1	12V/10W	6"	14	43	28	30
Xenon Festoon	TL212	1	12V/5W	3"	16	47	30	33
		1	12V/10W	6"	16	48	31	33
Halogen Bi-Pin	TL103	1	12V/20W	12"	16	66	56	60

Kick Spaces 3-watt Xenon lamps spaced on 4" centers provide adequate kick space lighting. Wider spacings can be used when the distance from trac to floor is greater than 4" or when even illumination is not required.

NOTE: Shiny flooring may cause lamp image reflections.

Cove Lighting

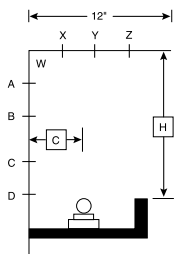

Placement Guidelines
 1. For uniform illumination o.c. lamp spacing must be equal to or less than lamp spacing from wall "C"

Footcandles on Horizontal and Vertical Planes (Test conducted with 70% reflectances at 23.5 volts)

Lamp Type	Lamp Spacing from Wall [C]	O.C. Lamp Spacing	Cove Height [H]	Footcandles on Vert. Plane (Wall)				Footcandles on Horiz. Plane (Ceiling)			
				A	B	C	D	W	X	Y	Z
24V, 10W Rigid Loop or Wedge Base Xenon Lamp	3"	3"	6"	111	155	162	31	176	164	93	44
	3"	3"	9"	62	89	155	21	118	121	93	54
	3"	3"	12"	42	56	120	15	83	87	78	56
	4"	4"	6"	88	111	105	23	124	123	85	38
Conversion factors for other lamps	LAMP MULTIPLIER										
	12V, 10W Festoon	1.33									
	12V, 10W Rigid Loop	1.11									
	12V, 10W Wedge Base	0.92									
24V, 5W Rigid Loop	0.44										
24V, 5W Wedge Base	0.32										
12V, 5W Rigid Loop	0.50										
12V, 5W Wedge Base	0.37										

NOTE: Frosted lamps typically provide slightly less lumen output, but more uniformity with wider spacings.

Maximum Run Length per 20 Amp Circuit

Lamp Type	Lamp Spacing	Lamp Spacing				
		2"	3"	4"	5"	6"
10 Watt Xenon Lamps	Lumens/Foot (24V Lamp)	-	340	255	204	170
	Maximum Run Length-24V	-	12'	16'	20'	24'
	Maximum Run Length-12V	-	6'	8'	10'	12'
5 Watt Xenon Lamps	Lumens/Foot (24V Lamp)	162	108	81	65	54
	Maximum Run Length-24V	16'	24'	32'	40'	48'
	Maximum Run Length-12V	8'	12'	16'	20'	24'
3 Watt Xenon Lamps	Lumens/Foot	93	62	42	37	31
	Maximum Run Length-12V	13'	20'	27'	33'	40'

Maximum Run Length per 25 Amp Circuit

Lamp Type	Lamp Spacing	Lamp Spacing				
		2"	3"	4"	5"	6"
10 Watt Xenon Lamps	Lumens/Foot (24V Lamp)	-	340	255	204	170
	Maximum Run Length-24V	10'	15'	20'	25'	30'
	Maximum Run Length-12V	5'	7.5'	10'	12.5'	15'
5 Watt Xenon Lamps	Lumens/Foot (24V Lamp)	162	108	81	65	54
	Maximum Run Length-24V	20'	30'	40'	50'	60'
	Maximum Run Length-12V	10'	15'	20'	25'	30'
3 Watt Xenon Lamps	Lumens/Foot	93	62	42	37	31
	Maximum Run Length-12V	17'	25'	34'	42'	50'